

ELVINO FLOOR DOUBLE

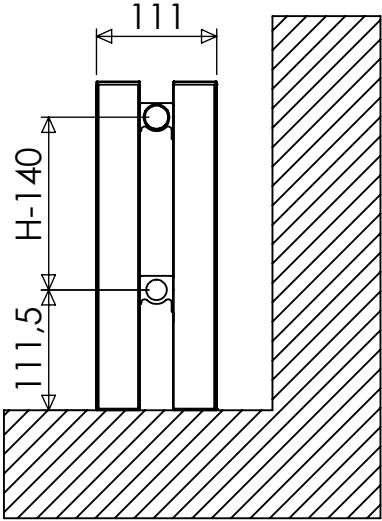

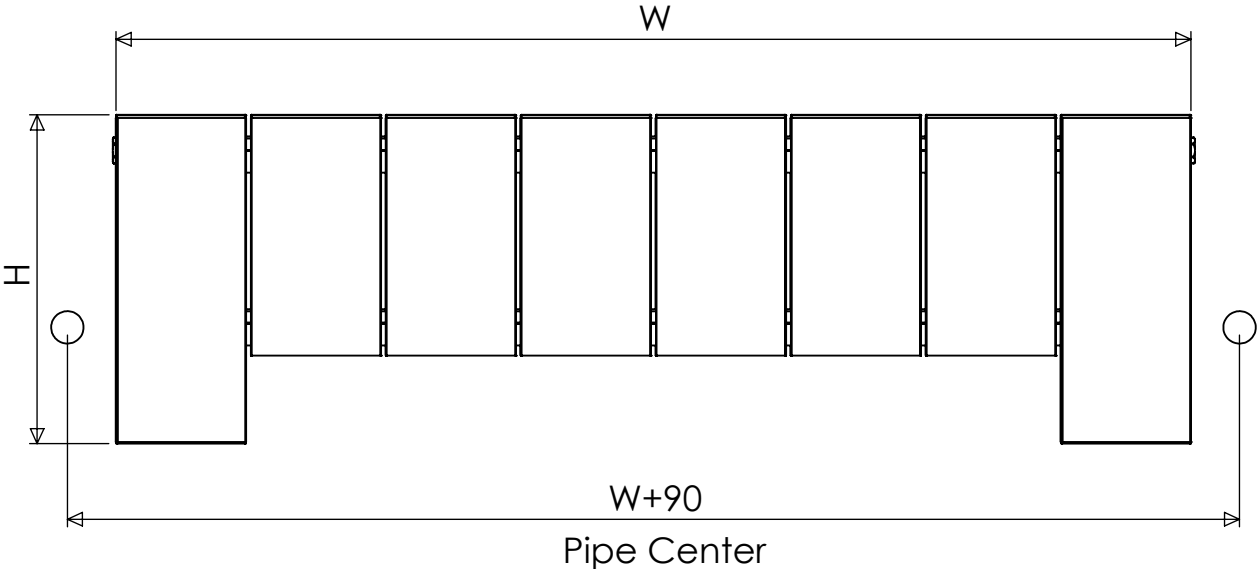



TECHNICAL DATA

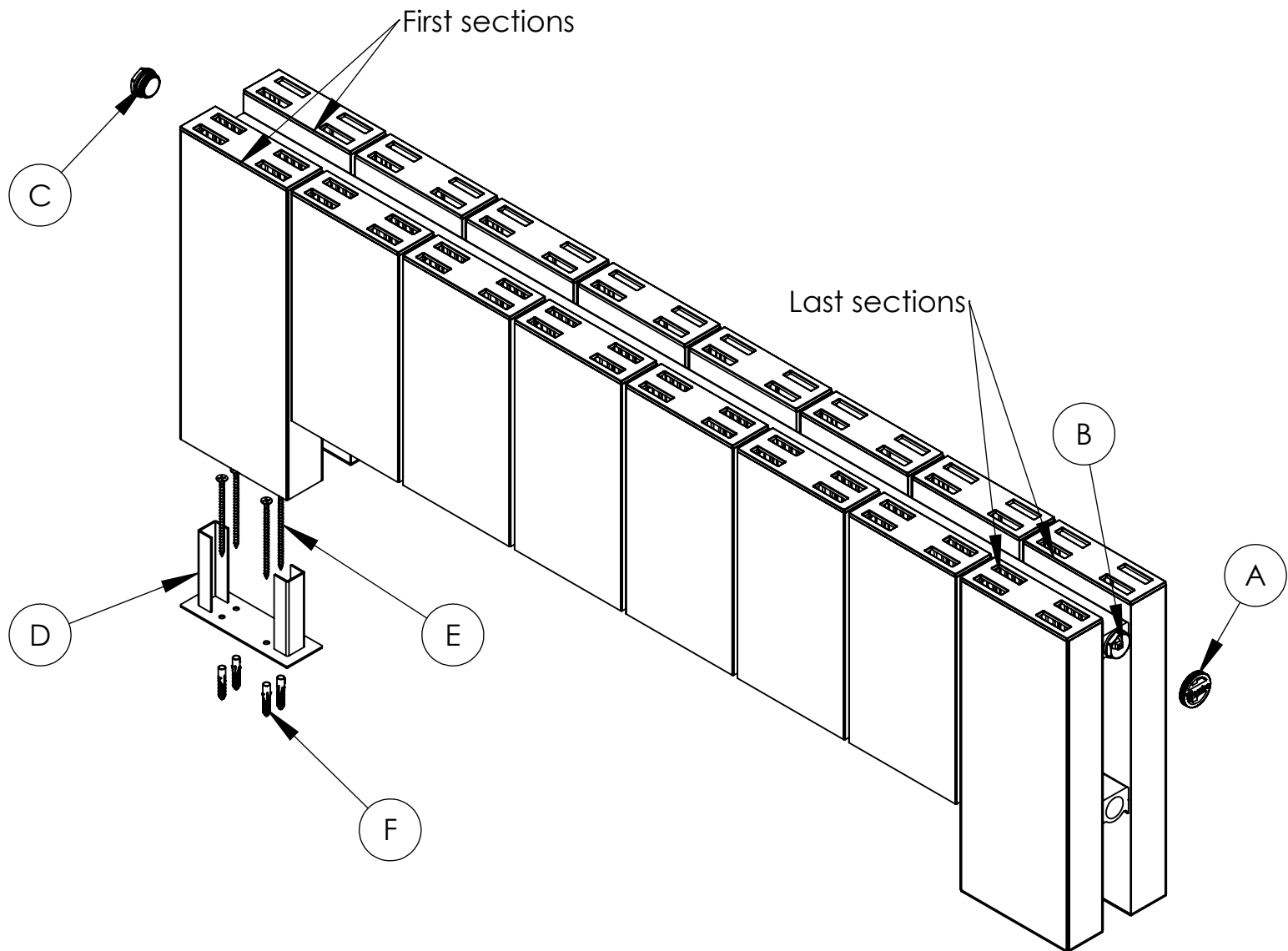

ELVINO FLOOR DOUBLE

FITTING INSTRUCTIONS



Key	Component	Qty
	A Bleeding Valve Key	1
	B Bleeding Valve 1/2 "	1
	C Blind tap	1
	D Floor Fixing Piece	4
	E Screw	16
	F Plug	16

Assembly Instructions

Use Carisa bleeding valve key (A) to turn bleeding valve on final installation (B).

Accurately mark out fixing pieces's holes on floor using spirit level.

Drill sixteen 8mm hole for each floor fixing piece (D).

Screw floor fixing piece (D) into plugs (F) with screws (E).

Position the first and last sections of the radiator centered on the floor fixings.