









Key	Component	Qty
	A Bleeding Valve Key	1
	B Bleeding Valve 1/2 "	1
	C Blind Tap	1
	D Friction Cups/Cushions	4
	E Upper Bracket	2
	F Lower Bracket	2
	G Screw-5,5x45mm	8
	H Wall Plug	8



Assembly Instructions

- Fit bleending valve (B) & blind tap (C).
- Use Carisa bleeding valve key (A) to turn bleeding valve (B).
- Accurately mark out bracket holes on wall using spirit level.
- Drill four 8mm diameter holes for upper brackets (E) and four 8mm diameter holes for bottom brackets(F).
- Friction cups (D) **MUST** be fitted to each mounting brackets (E,F) to suppress potential noise.
- Screw brackets (E,F) into wall plugs (H) with 5,5mm diameter x 45mm screws (G).
- Hang radiator by sliding the bosses on the back of the radiator into brackets (E,F).

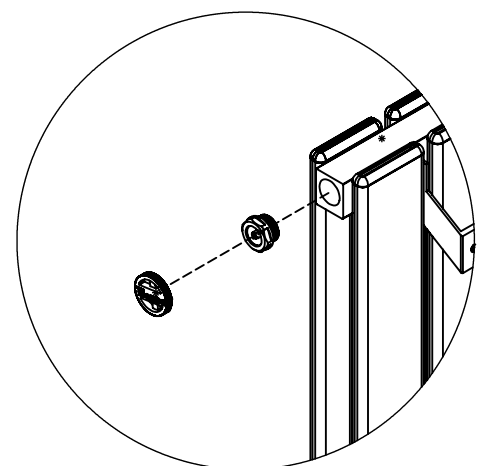
PLATA DOUBLE

TECHNICAL DATA

