

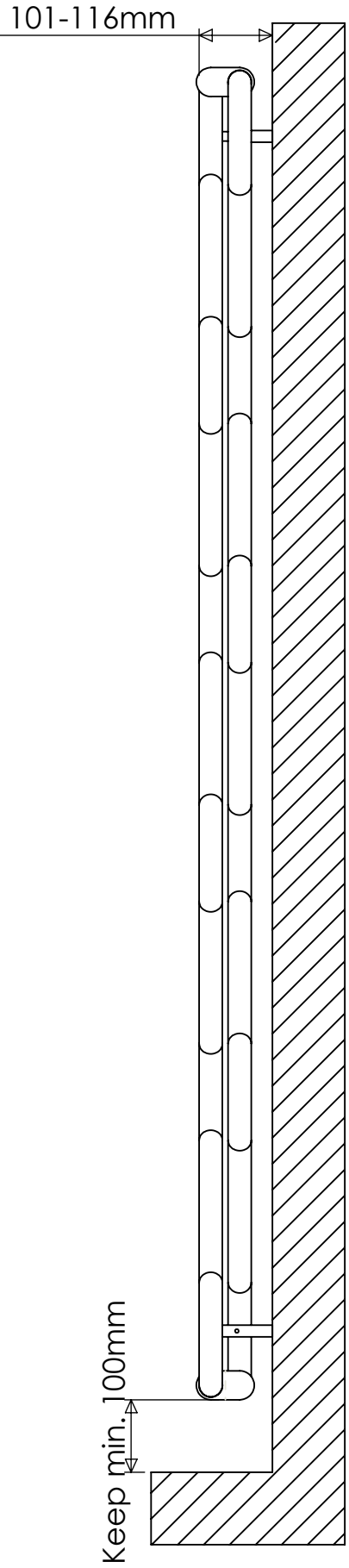

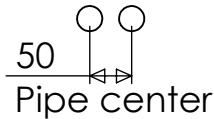

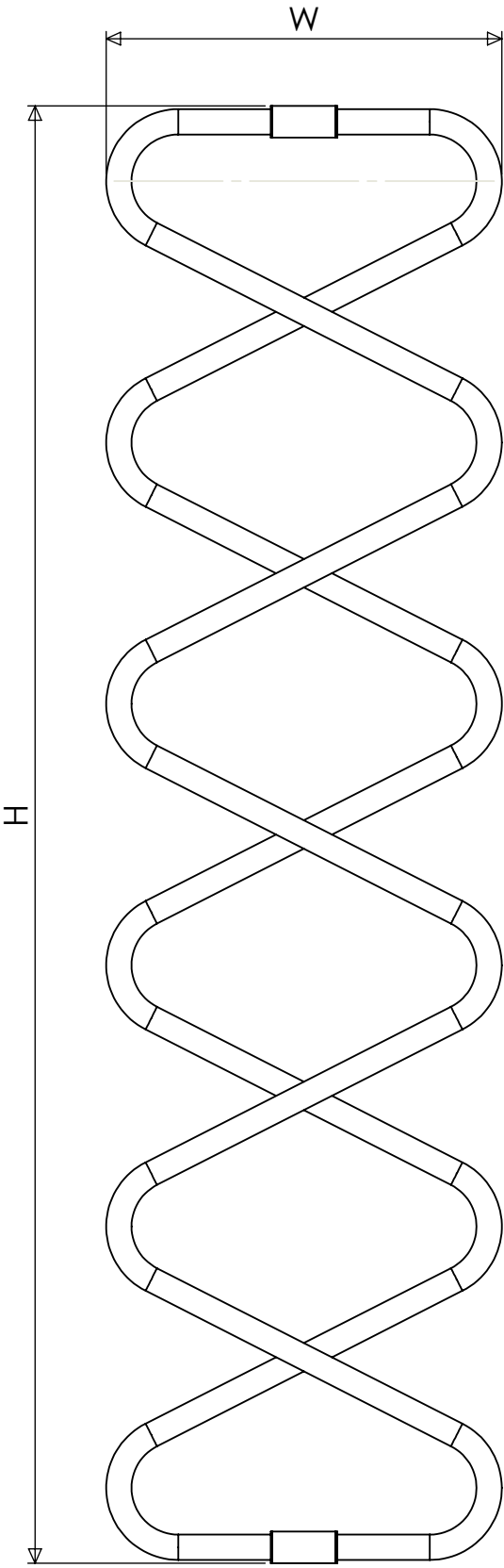

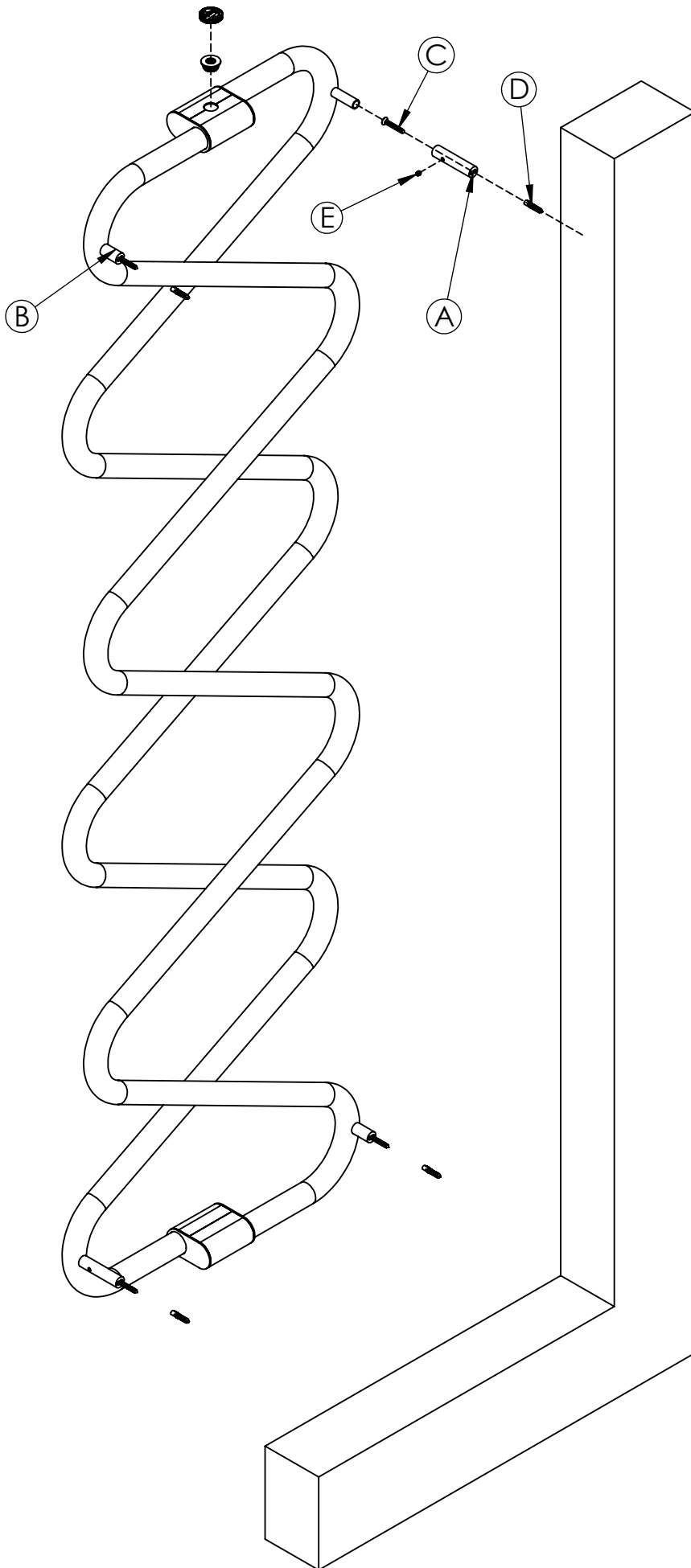

ZIGGY

TECHNICAL DATA





Key	Component	Qty
	A Bleeding Valve Key	1
	B Bleeding Valve 1/2 "	1
	C Long Bracket	2
	D Short Bracket	2
	E Screw-22x45mm	4
	F Wall Plug	4
	G Grub Screw	4

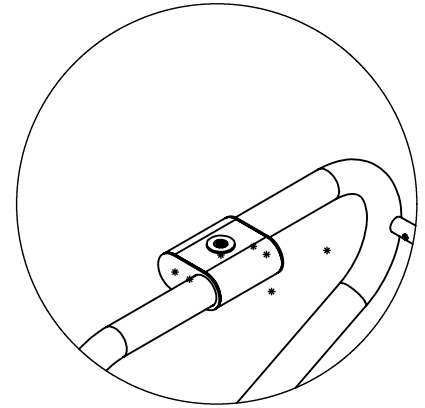

Assembly Instructions

Use Carisa bleeding valve key (A) to turn bleeding valve (B) on final installation.

Accurately mark out bracket holes on wall using spirit level.

Drill four 8mm hole for each brackets (A, B).

The front pipe brackets (C) should be long, the rear pipe brackets (D) should be short.

Screw brackets (C,D) into wall plugs (F) with 22 x 45mm screws (E).

Hang radiator by centering the studs into the brackets (C,D).

Secure the stud with the grub screw (G) after setting wall distance.